

PWM Control 3A Step-Down Converter

❖ GENERAL DESCRIPTION

AX3117/A/B consists of step-down switching regulator with PWM control. The device includes a reference voltage source, oscillation circuit, error amplifier, internal PMOS and etc.

AX3117/A/B provides low-ripple power, high efficiency, and excellent transient characteristics. The PWM control circuit is able to the duty ratio linearly forms 0 up to 100%. An over current protection and short circuit protection functions are built outside that it can set by a resistance. An external compensation is easily to system stable; the low ESR output capacitor can be used.

With the addition of an internal P-channel Power MOS, a coil, capacitors, and a diode connected externally, these ICs can function as step-down switching regulators. They serve as ideal power supply units for portable devices when coupled with the SOP-8L-EP package, providing such outstanding features as low current consumption. Since this converter can accommodate an input voltage up to 40V, it is also suitable for the operation via an AC adapter.

❖ FEATURES

- Input Voltage : 8V to 40V
- Duty ratio : 0% to 100% PWM control
- Oscillation frequency : 100K/300KHz
- Thermal Shutdown function.
- Short Circuit Protect (SCP).
- Built-in internal SW P-channel MOS.
- Current mode non-synchronous PWM converter
- External current limit setting.
- Under Voltage Lockout.
- Over Voltage Protection.
- Line-compensation built in.
- SOP-8L-EP Pb-Free package.

❖ BLOCK DIAGRAM

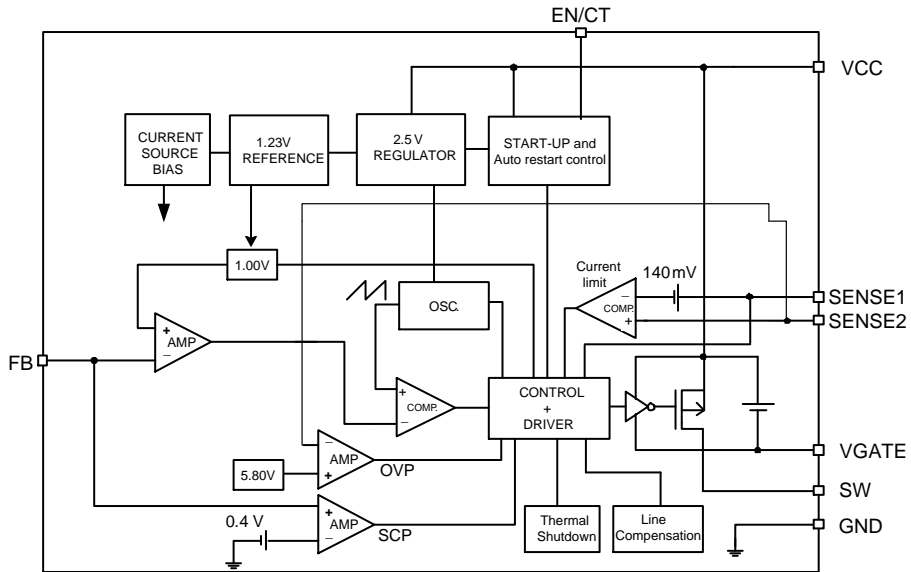

❖ PIN ASSIGNMENT

The package of AX3117/A/B is SOP-8L-EP; the pin assignment is given by:

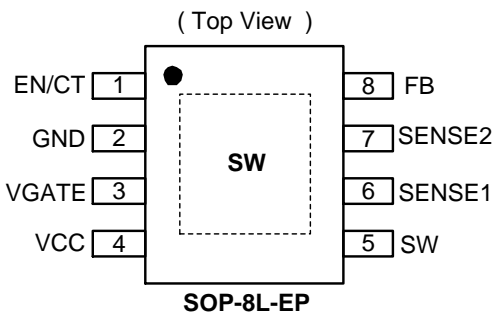

Name	Description
EN/CT	Shutdown and auto restart control pin
GND	GND pin
VGATE	Driver gate clamping pin. The pin must connect a 0.1uF capacitor to VIN
VCC	Operating voltage input
COMP	Compensation pin
SW	Switch pin. Connect external inductor and diode here
SENSE1	Current Sense input1
SENSE2	Current Sense input2
FB	Feedback pin

❖ ORDER/MARKING INFORMATION

Order Information	Top Marking
<p>AX3117 X XX X</p> <p>Frequency/Line Comp. Package Type Packing Blank : 100KHz/320mV ES: SOP-8L-EP Blank : Tube A: 300KHz/320mV A : Taping B: 100KHz/150mV</p>	<p>Logo ← AX 3 1 1 7 → Part number X Y Y W W X → ID code: internal WW: 01~52 Year: 11=2011 12=2012</p> <p>Blank: AX3117 A: AX3117A B: AX3117B</p>

❖ **ABSOLUTE MAXIMUM RATINGS** (at $T_A = 25^\circ\text{C}$)

Characteristics	Symbol	Rating	Unit
VIN Pin Voltage	V_{IN}	GND - 0.3 to GND + 45	V
Feedback Pin Voltage	V_{FB}	GND - 0.3 to V_{IN}	V
SENSE1/2, EN/CT Pin Voltage		GND - 0.3 to 6	V
Switch Pin Voltage	V_{SW}	GND - 0.3 to $V_{IN} + 0.3$	V
Power Dissipation	PD	$(T_J - T_A)/\theta_{JA}$	W
Storage Temperature Range	T_{ST}	-40 to +165	$^\circ\text{C}$
Operating Temperature Range	T_{OP}	-30 to +130	$^\circ\text{C}$
Operating Supply Voltage	V_{OP}	+7.5 to +40	V
Output Current	I_{OUT}	0 to 3	A
Thermal Resistance from Junction to case	θ_{JC}	15	$^\circ\text{C/W}$
Thermal Resistance from Junction to ambient	θ_{JA}	40	$^\circ\text{C/W}$

Note : θ_{JA} is measured with the PCB copper are (need connect to Exposed pad) of approximately 1 in²(Multi-layer).

❖ **ELECTRICAL CHARACTERISTICS**

($V_{IN}=12\text{V}$, $T_A=25^\circ\text{C}$, unless otherwise specified)

Characteristics	Symbol	Conditions	Min	Typ	Max	Units
Feedback Voltage	V_{FB}	$I_{OUT}=10\text{mA}$	0.98	1.00	1.02	V
Under Voltage Lockout	U_{VLO}	Falling	-	5.8	-	V
UVLO Hysteresis	-		-	1.6	-	V
OVP detect voltage	V_{OVP}	Internal define	-	6	-	V
Line Regulation	-	$V_{IN}=10 \sim 40\text{V}$, $I_{OUT}=10\text{mA}$	-	0.5	1	%
Load Regulation	-	$I_{OUT}=0\sim 2\text{A}$, $R_{SENSE} = 50\text{m}\Omega$				mV
		AX31117/A	+270	+320	+370	
		AX3117B	+100	+150	+200	
Quiescent Current	I_{CCQ}	$V_{FB} = 1.5\text{V}$, force driver off.	-	5	8	mA
Oscillator frequency	F_{OSC}	$I_{OUT} = 0.5\text{A}$				KHz
		AX3117/B	70	100	130	
		AX3117A	240	300	360	
Max. Duty Cycle (ON)	DC	Force driver on $V_{FB} = 0.6\text{V}$	-	100	-	%
Min. Duty Cycle (OFF)		Force driver off $V_{FB} = 1.5\text{V}$	-	0	-	%
Internal MOSFET $R_{DS(ON)}$	$R_{DS(ON)}$	$V_{IN}=12\text{V}$, $I_{OUT} = 2\text{A}$	-	100	150	m Ω
Sense Voltage	V_{SENSE}	$V_{SENSE1}-V_{SENSE2}$	130	140	150	mV
Sense Voltage Hysteresis	$V_{SENSE-h}$		-	50	-	mV
EN/CT pin logic input threshold voltage	V_{EN}	Shutdown mode	-		0.3	V
	V_{CT}	Auto restart, $V_{FB}<0.4\text{V}$	0.5	-	1.5	
EN/CT pin current	$I_{EN/CT-C}$	Charge current	-	-26	-	μA
EN/CT pin current	$I_{EN/CT-D}$	Discharge current	-	1.8	-	μA
Thermal shutdown Temp	T_{SD}		-	150	-	$^\circ\text{C}$
Thermal Shutdown Hysteresis	T_{SH}		-	40	-	$^\circ\text{C}$

❖ APPLICATION CIRCUIT

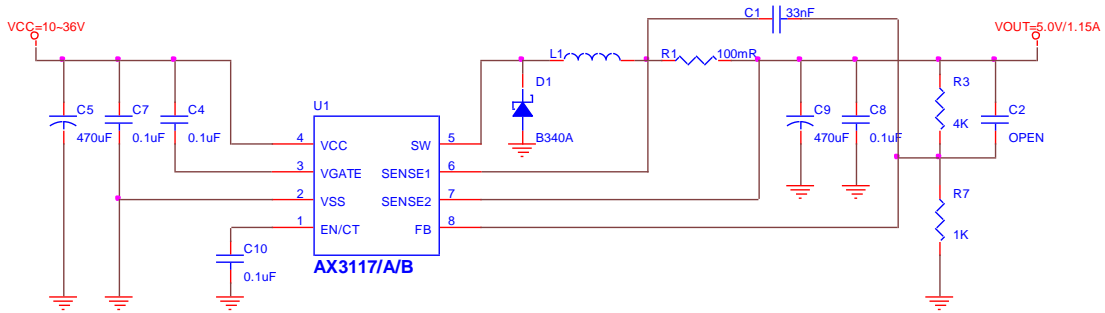

$$V_{OUT} = 1.0V \times \left(1 + \frac{R2}{R1}\right)$$

L1 recommend value (V _{IN} =10~36V, V _{OUT} =5V)		
Version	AX3117/B	AX3117A
L1 Value (H)	66u	33u

❖ FUNCTION DESCRIPTIONS
SENSE1/2

The current limit sense pin, if $V_{SENSE1} - V_{SENSE2} \geq 140mV$, the over current is happened that it can turn-off driver cycle by cycle.

EN/CT

The pin is enable/shutdown and auto restart control functions. When system is normal operating, this pin is enable/shutdown function. Pulling this pin below a threshold voltage of under 0.3V shuts the regulator off, and pulling this pin from 0.5V to 1.5V turns the regulator on. However when V_{OUT} is short ($V_{FB} < 0.4V$), the auto restart function can be started that restart the regulator cycle by cycle. The cycle time is set by outside capacitor (C10). Please refer the below waveform and formula, the t2 cycle is regulator off time and t1 cycle is current limit time. The charge-current is 26uA and discharge-current is 1.8uA.

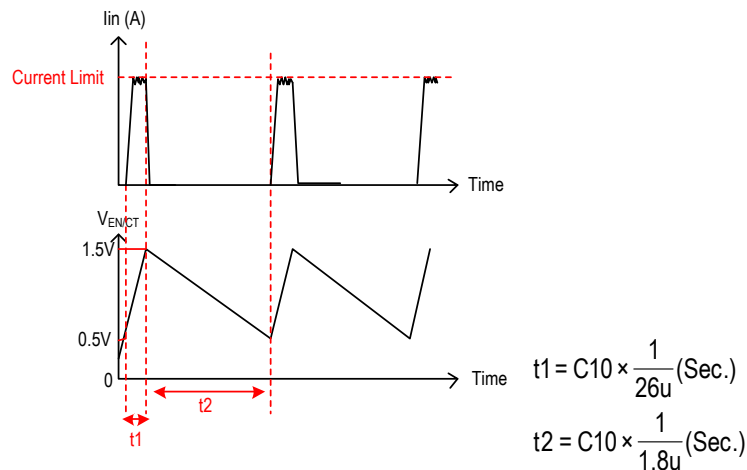

Under Voltage Lockout (UVLO)

To avoid error-operation of the device at low input voltages an under voltage lockout is included that disables the device, if the input voltage lower than 5.8V.

Current Limit Protection

The Current limit is set by outside resistance (R_{SENSE}), When the SENSE1-SENSE2 voltage larger than 140mV, the current limit is happened that driver can be turned off until the drop is small than 90mV. The current limit set according to the following equation:

$$\text{CurrentLimit(A)} = \frac{140\text{mV} + (140\text{mV} - 50\text{mV})}{2 \times R_{SENSE}}$$

The maximum output current table is shown as below; please refer the table to design.

R_{SENSE} (Ω)	Current Limit (A)
50m	2.3
75m	1.53
100m	1.15

Inductor Selection

For most designs, the different frequency can be reducing the inductor value; Please refer the table below.

L1 recommend value ($V_{IN}=10\sim 36\text{V}$, $V_{OUT}=5\text{V}$)		
Version	AX3117A	AX3117/B
L1 Value (H)	22~47u	66~100u

Where is inductor Ripple Current. Large value inductors lower ripple current and small value inductors result in high ripple currents. Choose inductor ripple current approximately 20% of the maximum load current 2A, $\Delta I_L=0.6A$. The DC current rating of the inductor should be at least equal to the maximum load current plus half the ripple current to prevent core saturation ($2A+0.3A$).

Input Capacitor Selection

This capacitor should be located close to the IC using short leads and the voltage rating should be approximately 1.5 times of the maximum input voltage. The RMS current rating requirement for the input capacitor of a buck regulator is approximately 1/2 the DC load current. A low ESR input capacitor sized for maximum RMS current must be used. A 220~470 μ F low ESR capacitor for most applications is sufficient.

Output Capacitor Selection

The output capacitor is required to filter the output and provide regulator loop stability. The important capacitor parameters are; the 100 KHz Equivalent Series Resistance (ESR), the RMS ripples current rating, voltage rating, and capacitance value. For the output capacitor, the ESR value is the most important parameter. The ESR can be calculated from the following formula.

$$V_{RIPPLE} = \Delta I_L \times ESR = 0.6A \times 80m\Omega = 48mV$$

An aluminum electrolytic capacitor's ESR value is related to the capacitance and its voltage rating. In most case, higher voltage electrolytic capacitors have lower ESR values. Most of the time, capacitors with much higher voltage ratings may be needed to provide the low ESR values required for low output ripple voltage. System stability is depending on output capacitor's ESR, Correct to choose output capacitor's ESR is very important. It is recommended to using a 220~470 μ F, the ESR values range is 40~130m Ω .

Thermal Considerations

The SOP-8L-EP package needs a heat sink under most conditions. The heat sink connect exposed pad of AX3117/A/B to obtain best effect. The size of the heat sink depends on the input voltage, the output voltage, the load current and the ambient temperature.

❖ TYPICAL CHARACTERISTICS

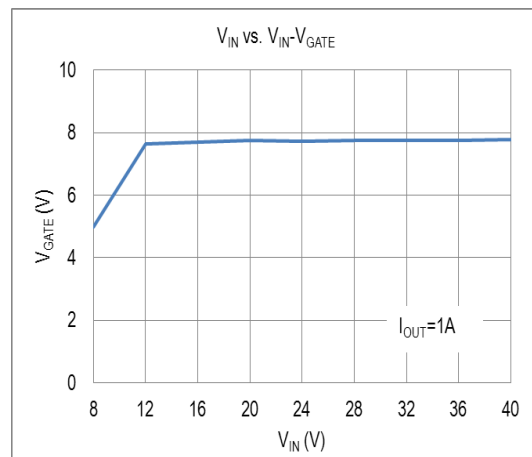
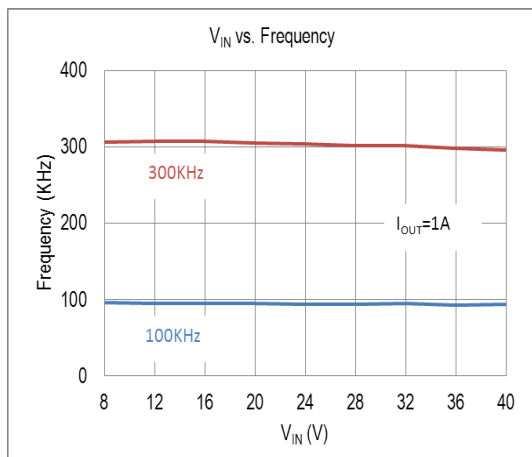
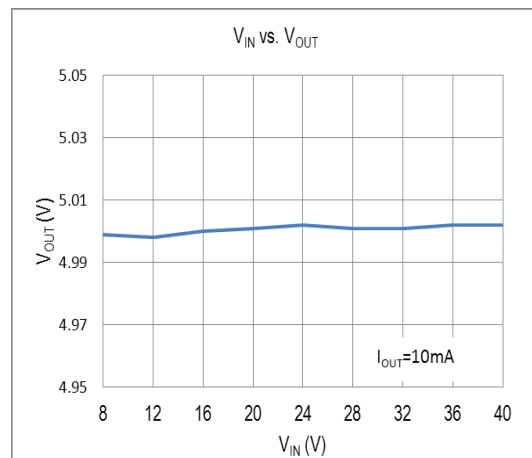
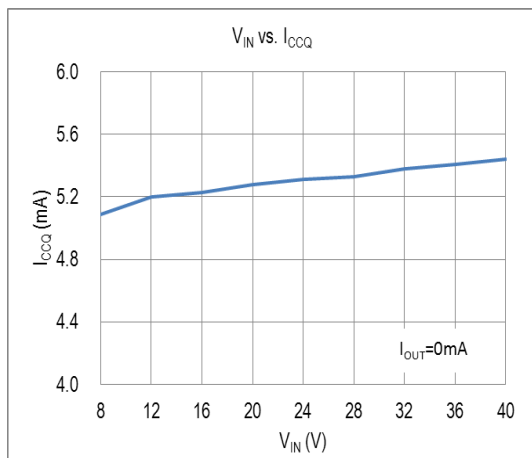

❖ TYPICAL CHARACTERISTICS (CONTINUOUS)

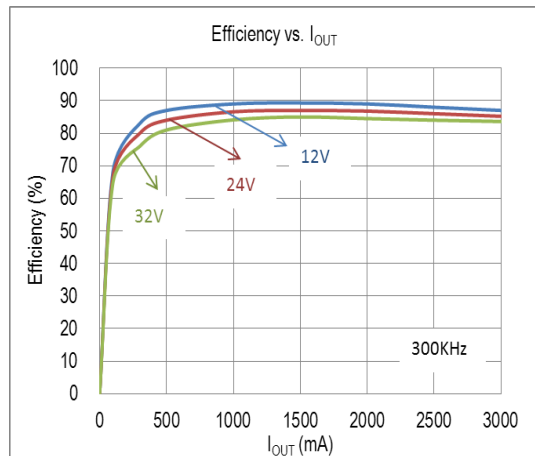
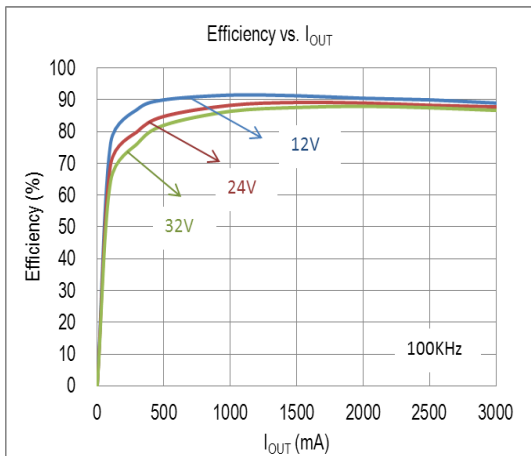
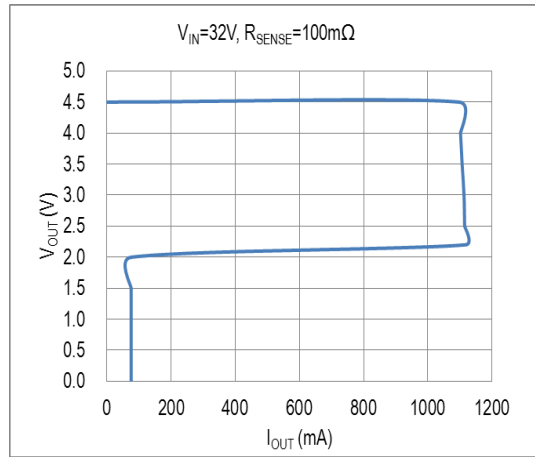
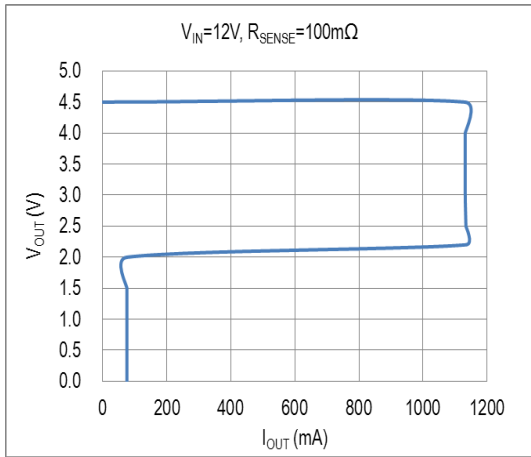
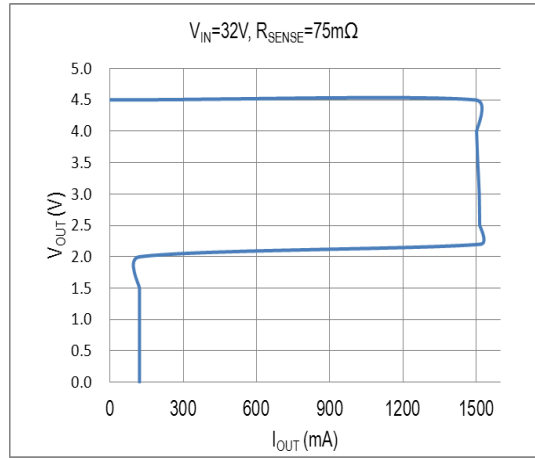
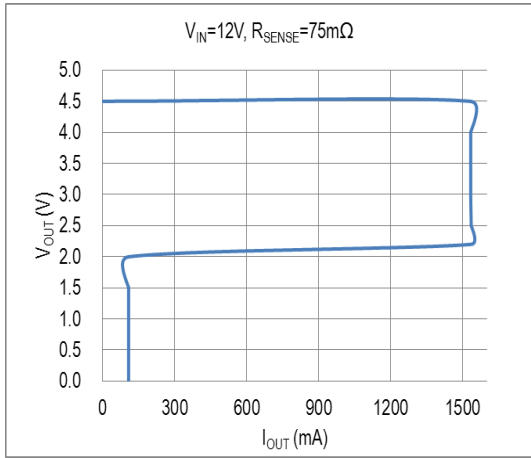

❖ TYPICAL CHARACTERISTICS (CONTINUOUS)

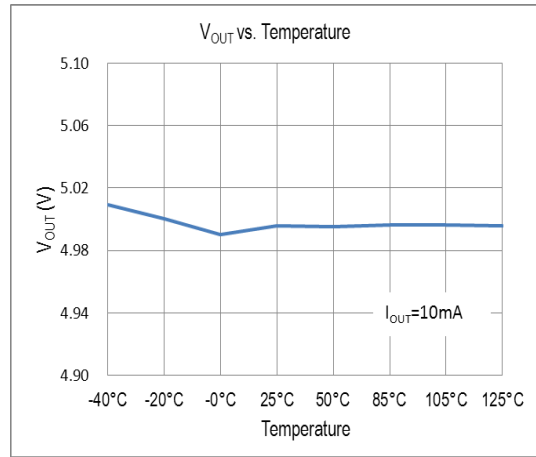
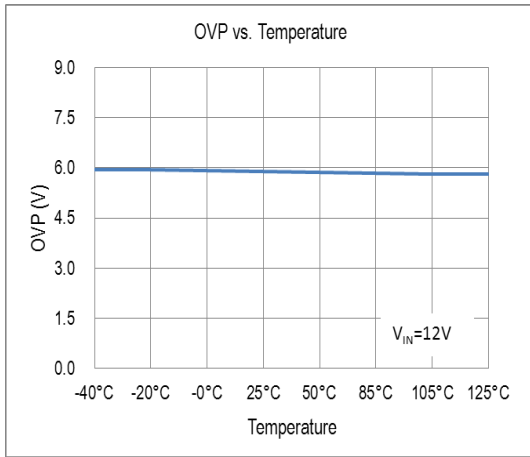
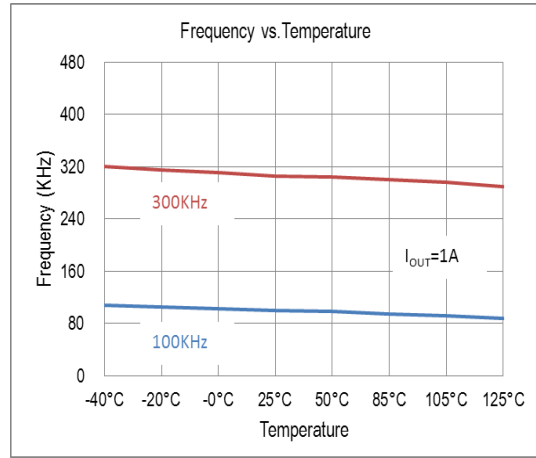
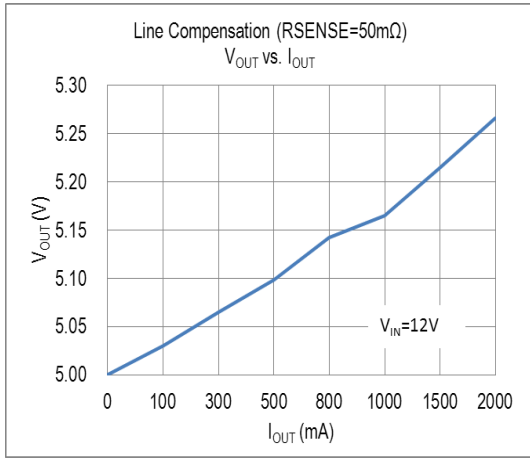

❖ **TYPICAL CHARACTERISTICS (CONTINUOUS)**

$V_{IN}=12V, V_{OUT}=5V, I_{OUT}=1.2A, CEN=0.1\mu$

$V_{IN}=32V, V_{OUT}=5V, I_{OUT}=1.2A, CEN=0.1\mu$

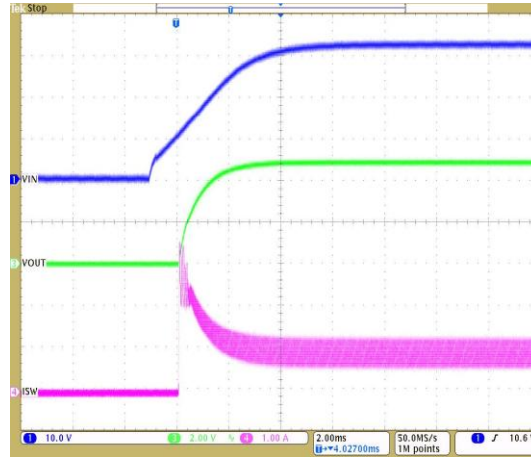
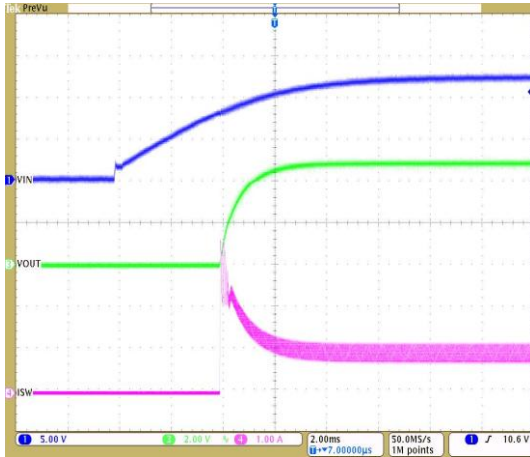

THERMAL SHUT DOWN RELEASE
 $V_{IN}=32V, V_{OUT}=5V, I_{OUT}=1.5A$

SHORT RELEASE
 $V_{IN}=32V, V_{OUT}=5V, I_{OUT}=1A$

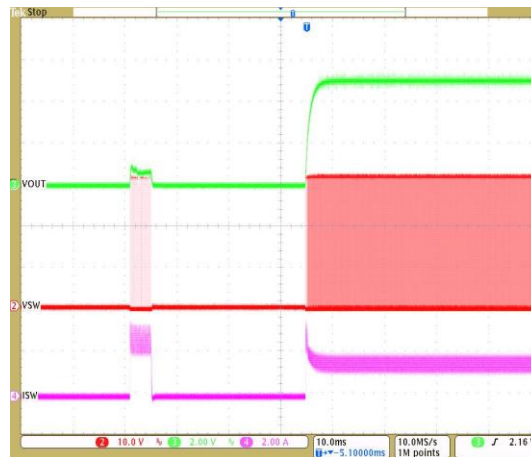
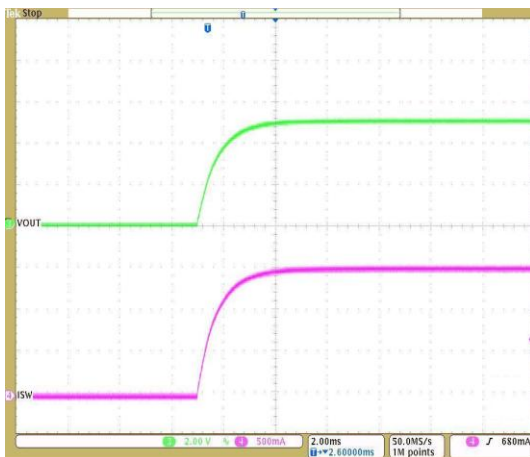

❖ **TYPICAL CHARACTERISTICS (CONTINUOUS)**

AX3117/A

Line Compensation ($R_{SENSE}=50m\Omega$), $I_{OUT}=2A$

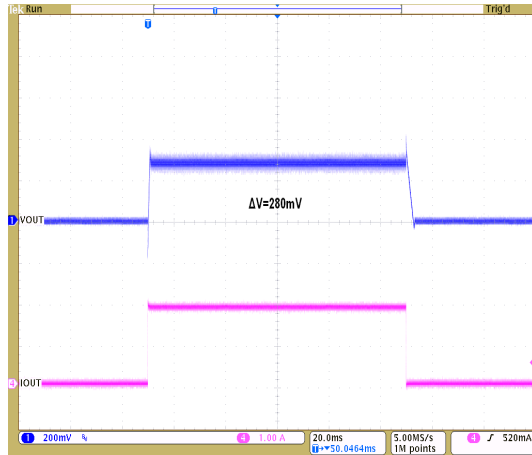

Line Compensation ($R_{SENSE}=50m\Omega$), $I_{OUT}=1A$

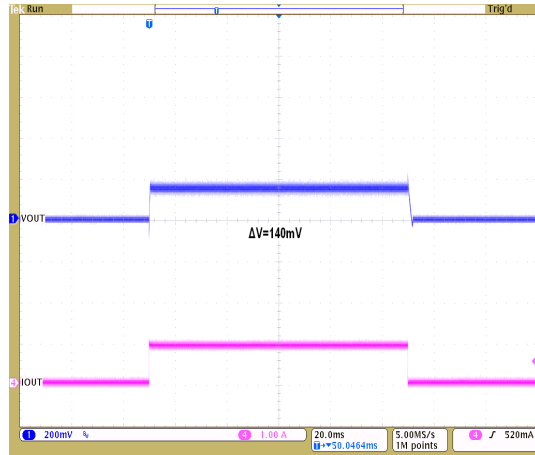

AX3117B

Line Compensation ($R_{SENSE}=50m\Omega$), $I_{OUT}=2A$

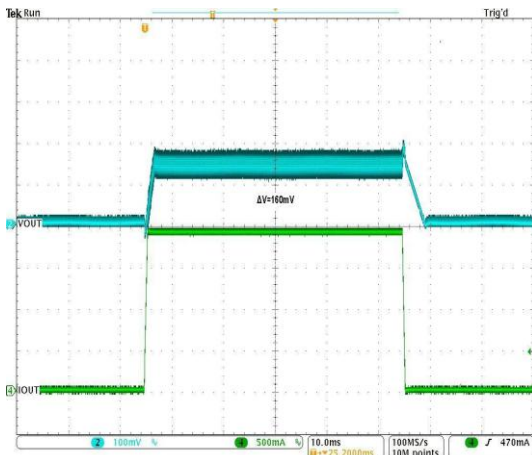

Line Compensation ($R_{SENSE}=50m\Omega$), $I_{OUT}=1A$

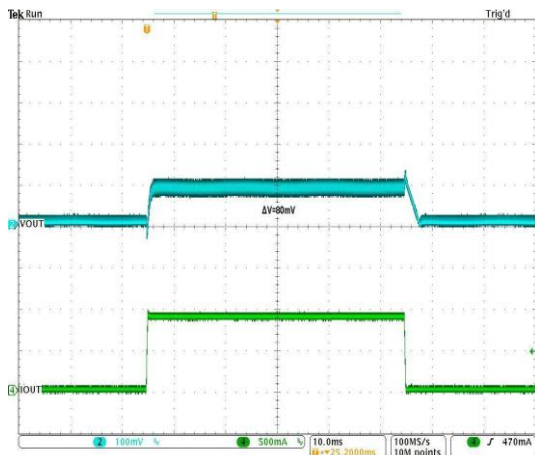

❖ PACKAGE OUTLINES

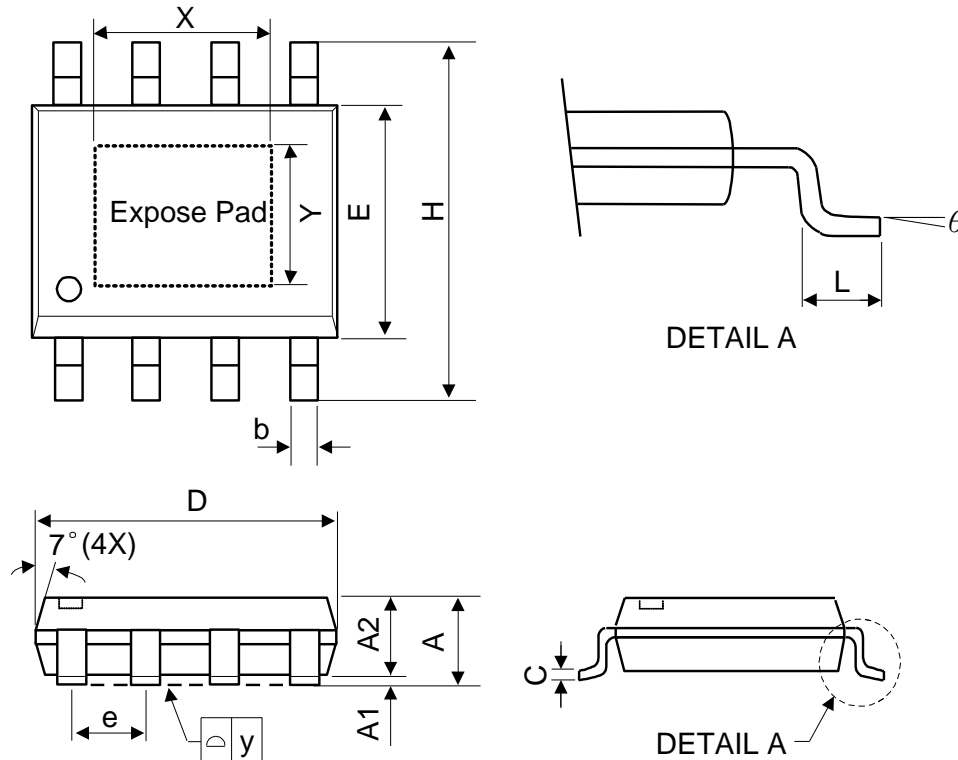

Symbol	Dimensions in Millimeters			Dimensions in Inches		
	Min.	Nom.	Max.	Min.	Nom.	Max.
A	-	-	1.75	-	-	0.069
A1	0	-	0.15	0	-	0.06
A2	1.25	-	-	0.049	-	-
C	0.1	0.2	0.25	0.0075	0.008	0.01
D	4.7	4.9	5.1	0.185	0.193	0.2
E	3.7	3.9	4.1	0.146	0.154	0.161
H	5.8	6	6.2	0.228	0.236	0.244
L	0.4	-	1.27	0.015	-	0.05
b	0.31	0.41	0.51	0.012	0.016	0.02
e	1.27 BSC			0.050 BSC		
y	-	-	0.1	-	-	0.004
X	-	2.34	-	-	0.092	-
Y	-	2.34	-	-	0.092	-
θ	0°	-	8°	0°	-	8°

Mold flash shall not exceed 0.25mm per side

JEDEC outline: MS-012 BA